

4m/150kg

60x60

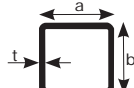

	a	b	t	kg/m
Fe	60	60	4	6,2
Zn	60	60	4	6,2

v min	v max	d1	d2	A	B	C	D	E	F	G
125	145	51	51	165	45	145	115	62	13	100

	SV-60x60 classic	SV-60x60 Zn classic	SV-60x60 ECO
H/02-60x60-Fe	6m	-	-
H/02-60x60-Zn	-	6m	-
H/34BP-4-60x60	2x	2x	2x
H/14N-60x60	1x	1x	1x
H/15P-60	1x	1x	1x
H/258-60x60	1x	1x	1x

6m/275kg

60x60

inox

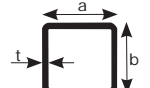

	a	b	t	kg/m
INOX	60	60	3	4,7

v	d1	d2	A	B	C	D	E	F	G
110	51	51	170	45	170	140	61	13	100

	SV-60x60 inox-classic
H8/02-60x60	6m
H8/34-4-60x60	2x
H8/14N-60x60	1x
H8/15P-60	1x
H8/40-60x60	1x

4m/150kg

70x60

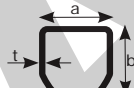

	a	b	t	kg/m
Fe	70	60	3,5	5,6
Zn	70	60	3,5	5,6

v min	v max	d1	d2	A	B	C	D	E	F	G
135	155	-	48	205	51	190	150	95	17	140

	SV-70x60 classic	SV-70x60 Zn classic	SV-70x60 ECO
H/02-70x60-Fe	6m	-	-
H/02-70x60-Zn	-	6m	-
H/34B-4-70x60	2x	2x	2x
H/14N-70x60	1x	1x	1x
H/15P-70	1x	1x	1x
H/40-70x60P	1x	1x	1x

4m/175kg

70x70

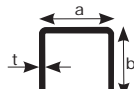
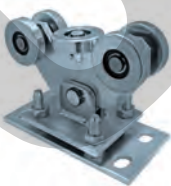

	a	b	t	kg/m
Fe	70	70	4	7,4
Zn	70	70	4	7,4

v min	v max	d1	d2	A	B	C	D	E	F	G
145	165	60	60	195	58	200	150	55	18	100

	SV-70x70 classic	SV-70x70 Zn classic	SV-70x70 ECO
H/02-70x70-Fe	6m	-	-
H/02-70x70-Zn	-	6m	-
H/34-4-70x70P	2x	2x	2x
H/14N-70x70	1x	1x	1x
H/15P-70	1x	1x	1x
H/258-70x70	1x	1x	1x

4m/175kg

70x70

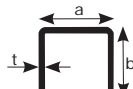

	a	b	t	kg/m
Fe	70	70	4	7,4
Zn	70	70	4	7,4

v min	v max	d1	d2	A	B	C	D	E	F	G
130	150	60	60	205	58	180	140	60	18	120

	SV-70x70BP classic	SV-70x70BP -Zn classic
H/02-70x70-Fe	6m	-
H/02-70x70-Zn	-	6m
H/34BP-4-70x70	2x	2x
H/14N-70x70	1x	1x
H/15P-70	1x	1x
H/258-70x70	1x	1x
M16x30	8x	8x

4m/200kg

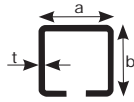

	a	b	t	kg/m
Fe	80	80	5	10,2
Zn	78	78	4	8,2

v min	v max	d1	d2	A	B	C	D	E	F	G
155	175	68	68	210	60	180	140	60	18	120

	SV-80x80 classic	SV-80x80 Zn classic	SV-80x80 ECO
H/02-80x80-Fe	6m	-	-
H/02-80x80-Zn	-	6m	-
H/34-4-80x80P	2x	2x	2x
H/14N-80x80	1x	1x	1x
H/15P-80	1x	1x	1x
H/258-80x80	1x	1x	1x

80x80

6m/300kg

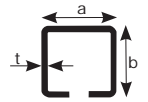
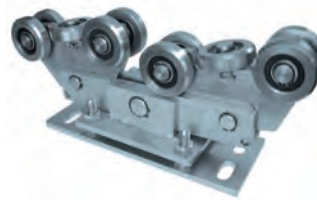

	a	b	t	kg/m
Fe	80	80	5	10,2
Zn	78	78	4	8,2

v min	v max	d1	d2	A	B	C	D	E	F	G
166	186	68	68	450	60,5	300	250	70	18	120

	SV-80x80 heavy	SV-80x80 Zn heavy
H/02-80x80-Fe	9m (6+3m)	-
H/02-80x80-Zn	-	9m (6+3m)
H/34-8-80x80P	2x	2x
H/14N-80x80	1x	1x
H/15P-80	1x	1x
H/258-80x80	1x	1x

80x80

4m/200kg

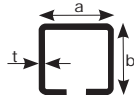

	a	b	t	kg/m
Fe	80	80	5	10,2
Zn	78	78	4	8,2

v min	v max	d1	d2	A	B	C	D	E	F	G
155	175	68	68	210	60	180	140	60	18	120

	SV-80x80BP classic	SV-80x80BP -Zn classic
H/02-80x80-Fe	6m	-
H/02-80x80-Zn	-	6m
H/34BP-4-80x80	2x	2x
H/14N-80x80	1x	1x
H/15P-80	1x	1x
H/258-80x80	1x	1x
M16x30	8x	8x

80x80

6m/250kg

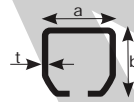

	a	b	t	kg/m
Fe	94	85	5	11,2
Zn	94	85	5	11,2

vmin	vmax	d1	d2	A	B	C	D	E	F	G
170	190	-	68	298	74	300	250	100	18	150

	SV-94x85 classic	SV-94x85 Zn classic	SV-94x85 ECO
H/02-94x85-Fe	9m (6+3m)	-	-
H/02-94x85-Zn	-	9m (6+3m)	-
H/34B-4-94x85	2x	2x	2x
H/14N-94x85	1x	1x	1x
H/15P-100	1x	1x	1x
H/40-94x85P	1x	1x	1x

94x85

8m/350kg

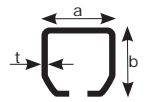

	a	b	t	kg/m
Fe	94	85	5	11,2
Zn	94	85	5	11,2

vmin	vmax	d1	d2	A	B	C	D	E	F	G
165	185	-	68	610	74	400	360	100	18	150

	SV-94x85 heavy	SV-94x85 Zn heavy
H/02-94x85-Fe	12m (6+6m)	-
H/02-94x85-Zn	-	12m (6+6m)
H/34B-8-94x85	2x	2x
H/14N-94x85	1x	1x
H/15P-100	1x	1x
H/40-94x85P	1x	1x

94x85

9m/600kg

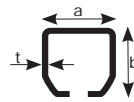

	a	b	t	kg/m
Fe	136	142	6	21,5
Zn	136	142	6	21,5

v min	v max	d1	d2	A	B	C	D	E	F	G
260	280	-	113	470	103,5	470	420	150	20	200

	SV-136x142 classic	SV-136x142 Zn classic
H/02-136x142-Fe	12m (6+6m)	-
H/02-136x142-Zn	-	12m (6+6m)
H/34B-4-136x142	2x	2x
H/14N-136x142	1x	1x
H/15P-145	1x	1x
H/40-136x142P	1x	1x

136x142

11,5m/700kg

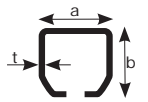

	a	b	t	kg/m
Fe	136	142	6	21,5
Zn	136	142	6	21,5

v min	v max	d1	d2	A	B	C	D	E	F	G
275	295	-	113	1025	100	1000	950	150	20	200

	SV-136x142 heavy	SV-136x142 Zn heavy
H/02-136x142-Fe	15m (6+6+3m)	-
H/02-136x142-Zn	-	15m (6+6+3m)
H/34B-8-136x142	2x	2x
H/14N-136x142	1x	1x
H/15P-145	1x	1x
H/40-136x142P	1x	1x

136x142

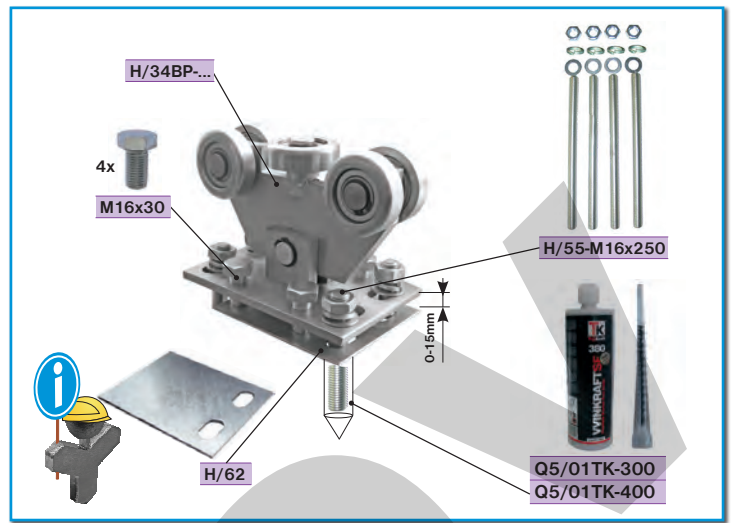
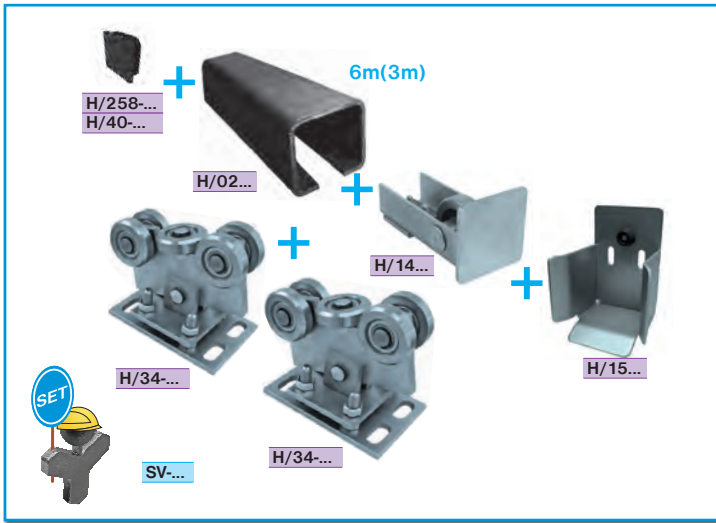

On-line prepočet / On-line calculation

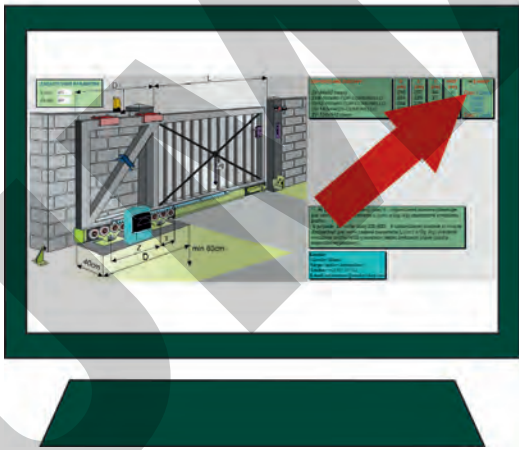
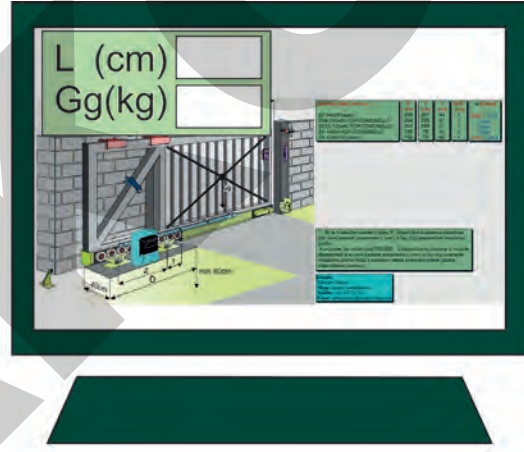

www.umakovshop.com